

# SCHOOL-SCOUT.DE

Unterrichtsmaterialien in digitaler und in gedruckter Form

## Auszug aus: *Sachunterricht mit Erstlesenden*

Das komplette Material finden Sie hier:

[School-Scout.de](https://www.school-scout.de)



# Inhaltsverzeichnis

Vorwort .....	4
Didaktische Hinweise .....	5
<b>Die Sonnenblume</b>	
Laufzettel .....	8
Die Teile der Sonnenblume 1 .....	9
Die Teile der Sonnenblume 2 .....	10
Die Farben der Sonnenblumen .....	11
Vom Kern zur Sonnenblume .....	12
Alles aus Sonnenblumen (Faltheft) .....	13
Tiere an der Sonnenblume 1 .....	14
Tiere an der Sonnenblume 2 .....	15
Sonnenblume (Gedicht) .....	16
Sonnenblumenkerne rösten .....	17
Steckbrief .....	18
<b>Licht und Schatten</b>	
Laufzettel .....	19
Die Taschenlampe 1 .....	20
Die Taschenlampe 2 .....	21
Natürliches oder künstliches Licht? .....	22
Licht und Schatten 1 .....	23
Licht und Schatten 2 .....	24
Schatten verändern sich (Experiment) .....	25
Wo ist der Schatten? .....	26
Schattenfiguren .....	27
Steckbrief .....	28
<b>Sicher zur Schule</b>	
Laufzettel .....	29
Der Schulweg 1 .....	30
Der Schulweg 2 .....	31
Die Farben der Ampel .....	32
Eine Straße überqueren .....	33
Verkehrszeichen 1 .....	34
Verkehrszeichen 2 .....	35
Sicher im Verkehr (Faltheft) .....	36
Sicher durch die Dunkelheit .....	37
Mein Schulweg .....	38
Steckbrief .....	39

## Das Eichhörnchen

Laufzettel .....	40
Der Körper des Eichhörnchens 1 .....	41
Der Körper des Eichhörnchens 2 .....	42
Was kann das Eichhörnchen? 1 .....	43
Was kann das Eichhörnchen? 2 .....	44
Was frisst das Eichhörnchen? .....	45
Die Feinde des Eichhörnchens (Faltheft) ...	46
Das Eichhörnchenjahr .....	47
Das Eichhörnchen im Wald .....	48
Steckbrief .....	49

## Müll und Recycling

Laufzettel .....	50
Mülltonnen 1 .....	51
Mülltonnen 2 .....	52
So viel Müll! .....	53
Wann verrottet es? (Domino) .....	54
Mein Mülltagebuch .....	55
Müll vermeiden .....	56
So wird Glas recycelt .....	57
Meine Müll-Gitarre .....	58
Steckbrief .....	59

## Die Jahreszeiten

Laufzettel .....	60
Die Jahreszeiten 1 .....	61
Die Jahreszeiten 2 .....	62
Welche Jahreszeit ist es? 1 .....	63
Welche Jahreszeit ist es? 2 .....	64
Das Jahr der Kastanie 1 .....	65
Das Jahr der Kastanie 2 .....	66
Die Monate (Leporello) .....	67
Wie ist das Wetter? .....	69
Welche Kleidung passt? .....	70
Es war eine Mutter (Lied) .....	71
Steckbrief .....	72



### Download:

- Lösungen
- Editierbare Word-Vorlagen der Laufzettel



# Die Teile der Sonnenblume 1

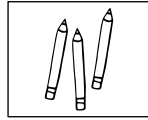
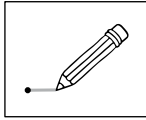
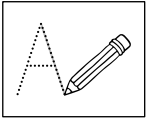

Kerne

Blatt  
Blatt

Blüte

Stängel

Wurzeln





# Steckbrief

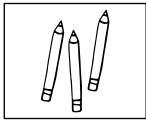

Das macht man aus Sonnenblumen:

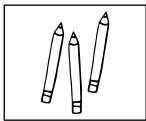
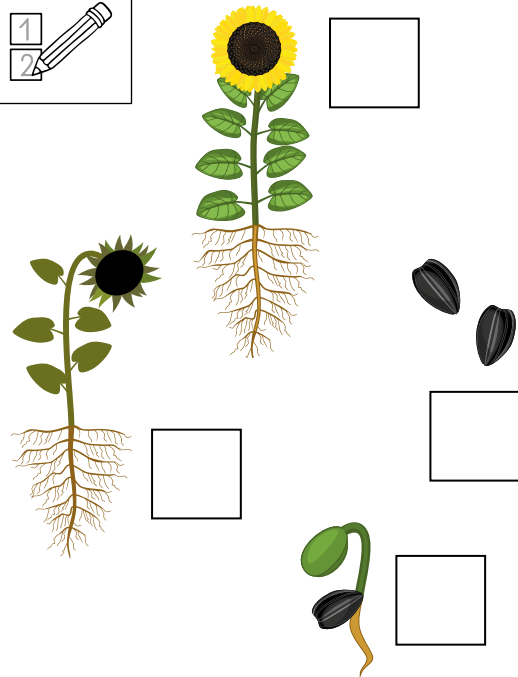
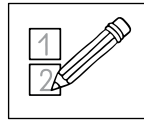
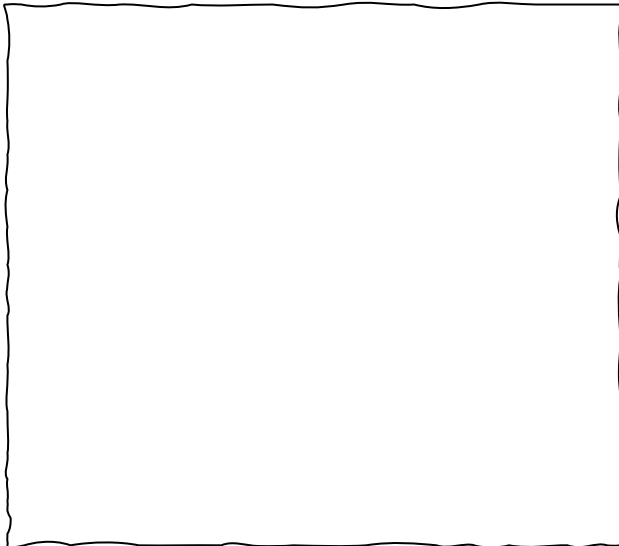

Welche Farben können die Blüten haben?

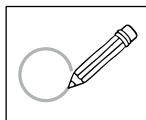
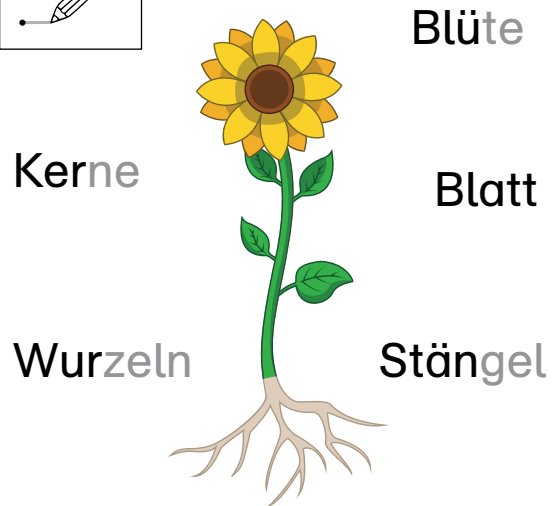
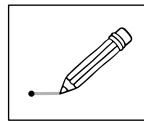
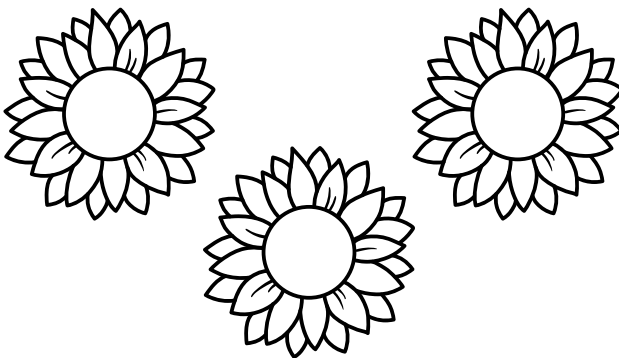

Welche Tiere mögen Sonnenblumen?





# Schattenfiguren

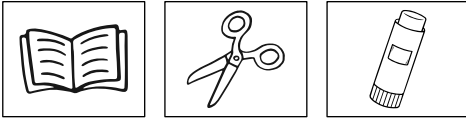



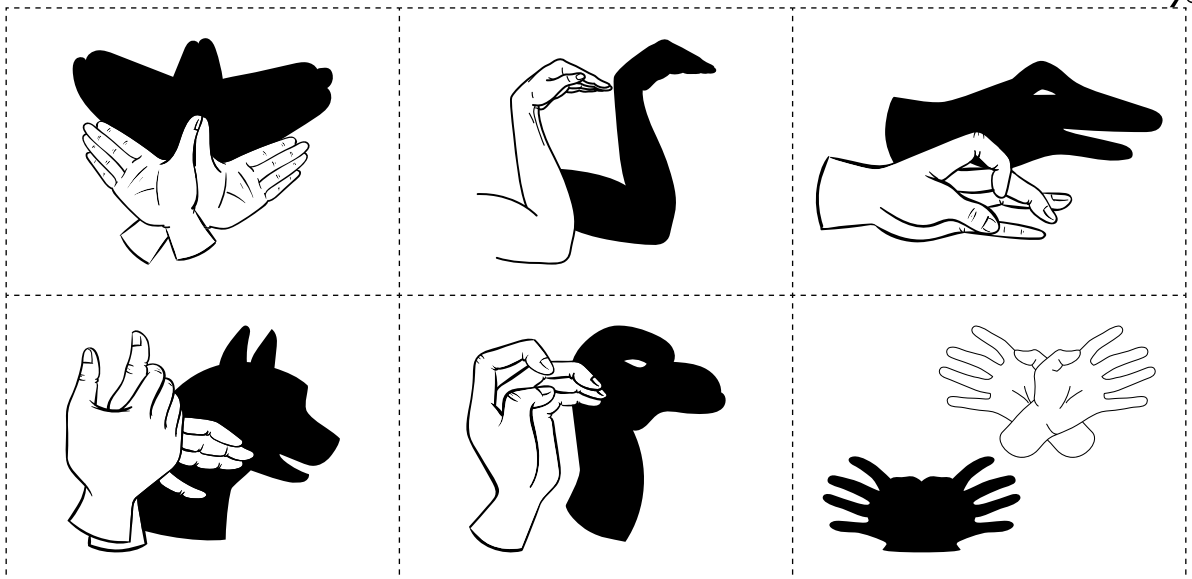

Vogel	Hund	Schwan
Kamel	Krokodil	Krabbe



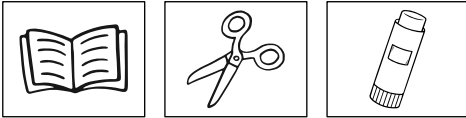

# Eine Straße überqueren

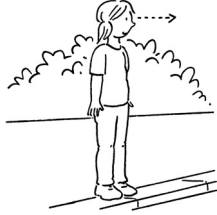
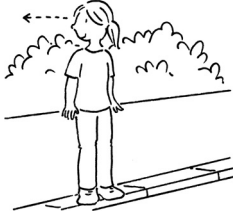
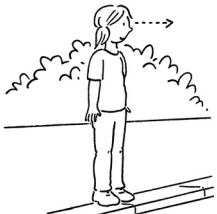

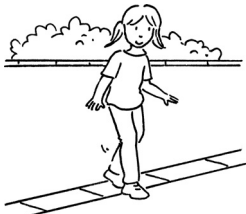
 <div data-bbox="159 728 555 958" style="border: 1px solid black; height: 100px; width: 100%;"></div>	 <div data-bbox="598 728 994 958" style="border: 1px solid black; height: 100px; width: 100%;"></div>	 <div data-bbox="1034 728 1436 958" style="border: 1px solid black; height: 100px; width: 100%;"></div>
 <div data-bbox="159 1236 555 1467" style="border: 1px solid black; height: 100px; width: 100%;"></div>	 <div data-bbox="598 1236 994 1467" style="border: 1px solid black; height: 100px; width: 100%;"></div>	 <div data-bbox="1034 1236 1436 1467" style="border: 1px solid black; height: 100px; width: 100%;"></div>

<p>Schau noch mal nach links.</p>	<p>Schau nach rechts.</p>	<p>Gehe zügig los.</p>
<p>Bleibe am Rand stehen.</p>	<p>Schau nach links.</p>	<p>Gehe auf die andere Straßenseite.</p>



# Steckbrief

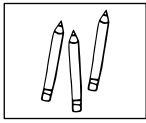

Wie wird das Kind gut gesehen?

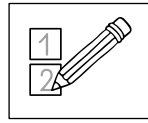

Wie überquerst du die Straße richtig?

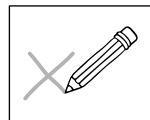

Was stimmt?

- Ich benutze den Zebrastreifen.
- Ich spiele an der Straße.
- Ich achte auf Radfahrende.
- Ich trage dunkle Kleidung.
- Ich bin an der Bushaltestelle vorsichtig.

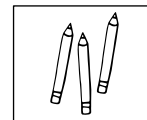

Bei Rot

\_\_\_\_\_ !

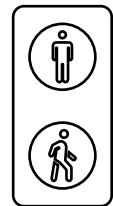

Bei Grün

\_\_\_\_\_ !

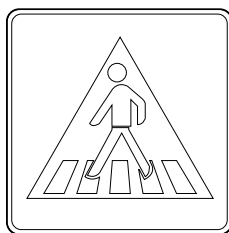
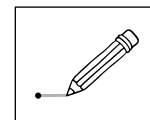
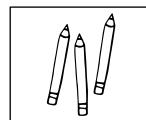
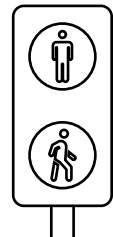

Fußgängerüberweg

Achtung, Ampel!

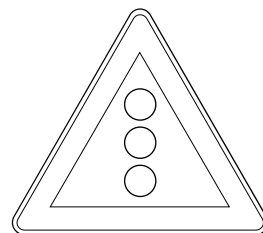



# Mülltonnen 1

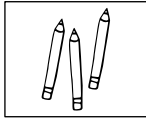
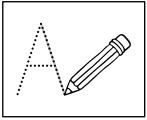

Restmüll

Biomüll

Gelbe Tonne

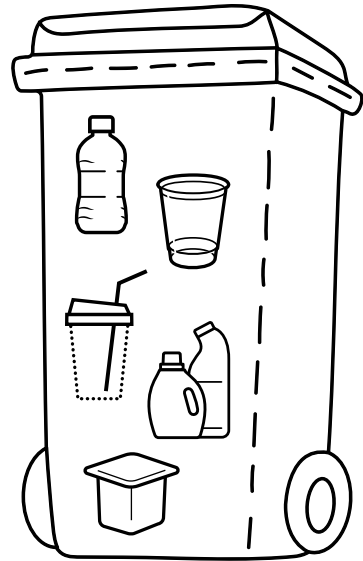
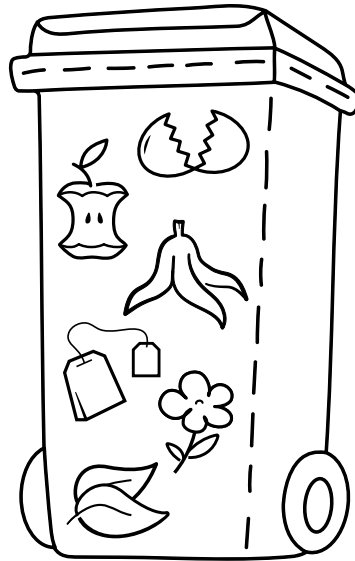
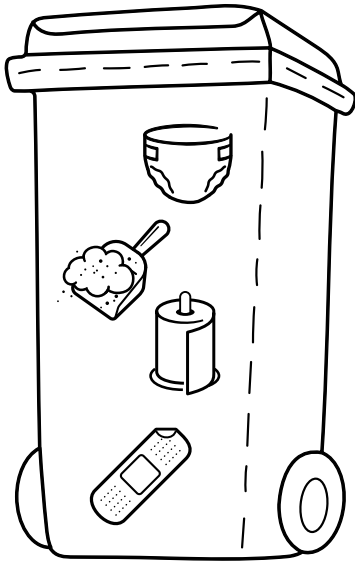

Altpapier

Alltglas

Sondermüll

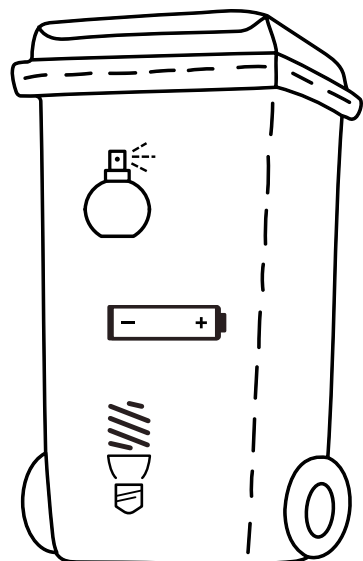
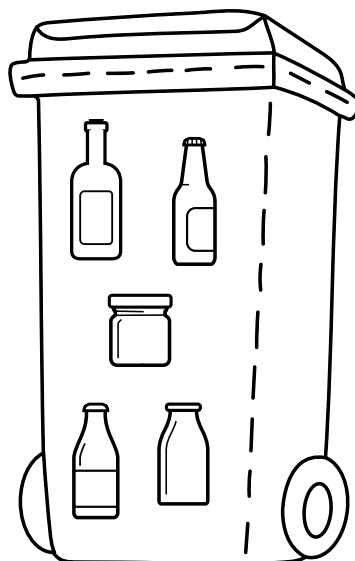
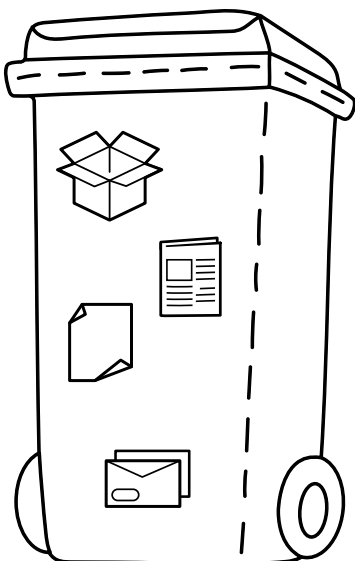



# Die Jahreszeiten 2

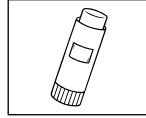
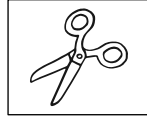
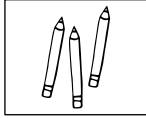

Winter	Herbst
Sommer	Frühling

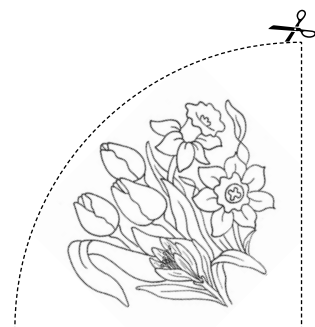
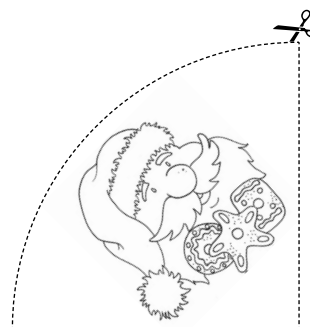
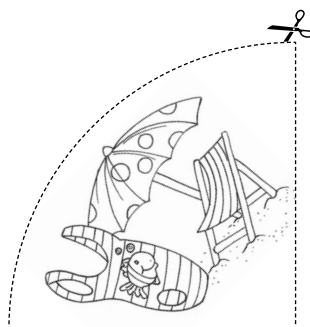
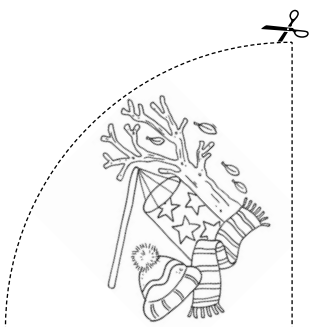
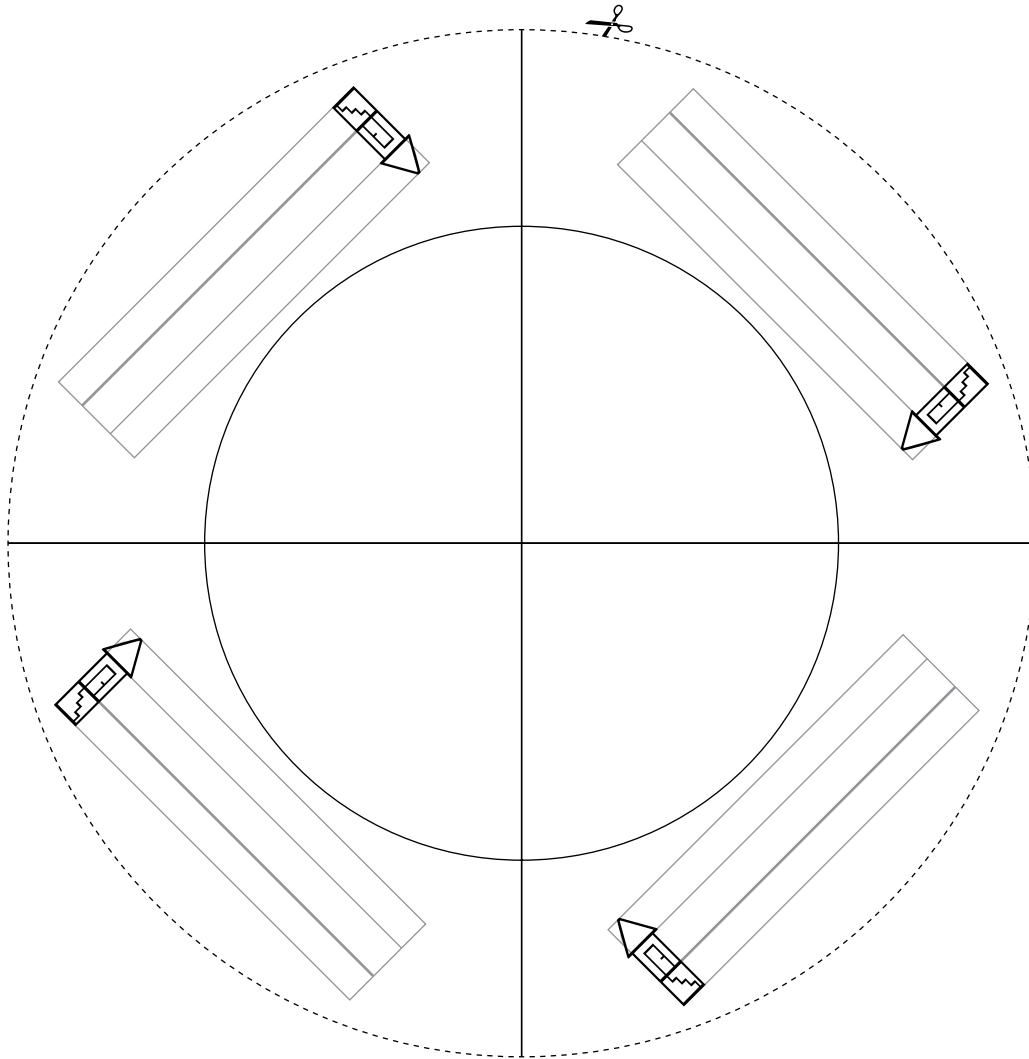



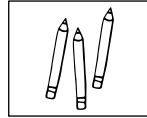
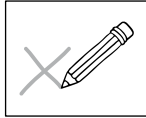

# Wie ist das Wetter?







Datum: \_\_\_\_\_

Diese Jahreszeit haben wir jetzt:

 <p><input type="checkbox"/> Frühling</p>	 <p><input type="checkbox"/> Sommer</p>
 <p><input type="checkbox"/> Herbst</p>	 <p><input type="checkbox"/> Winter</p>

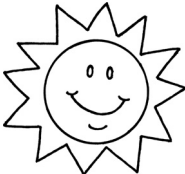
So ist das Wetter heute:

<p><input type="checkbox"/></p> 	<p><input type="checkbox"/></p> 	<p><input type="checkbox"/></p> 
<p><input type="checkbox"/></p> 	<p><input type="checkbox"/></p> 	<p><input type="checkbox"/></p> 

# SCHOOL-SCOUT.DE

Unterrichtsmaterialien in digitaler und in gedruckter Form

## Auszug aus: *Sachunterricht mit Erstlesenden*

Das komplette Material finden Sie hier:

[School-Scout.de](https://www.school-scout.de)

